

Descrizione	Miscelatore doccia ad incasso
Colore	Cromo
Codice fornitore	361801S
Codice catalogo	401 678 231
Peso	-

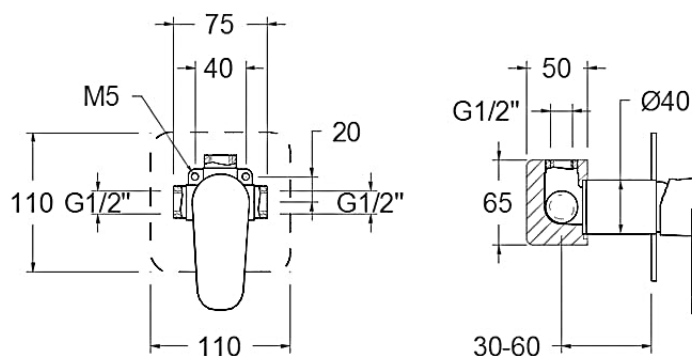

LO PRESTI
casa arredò